

Family 1358

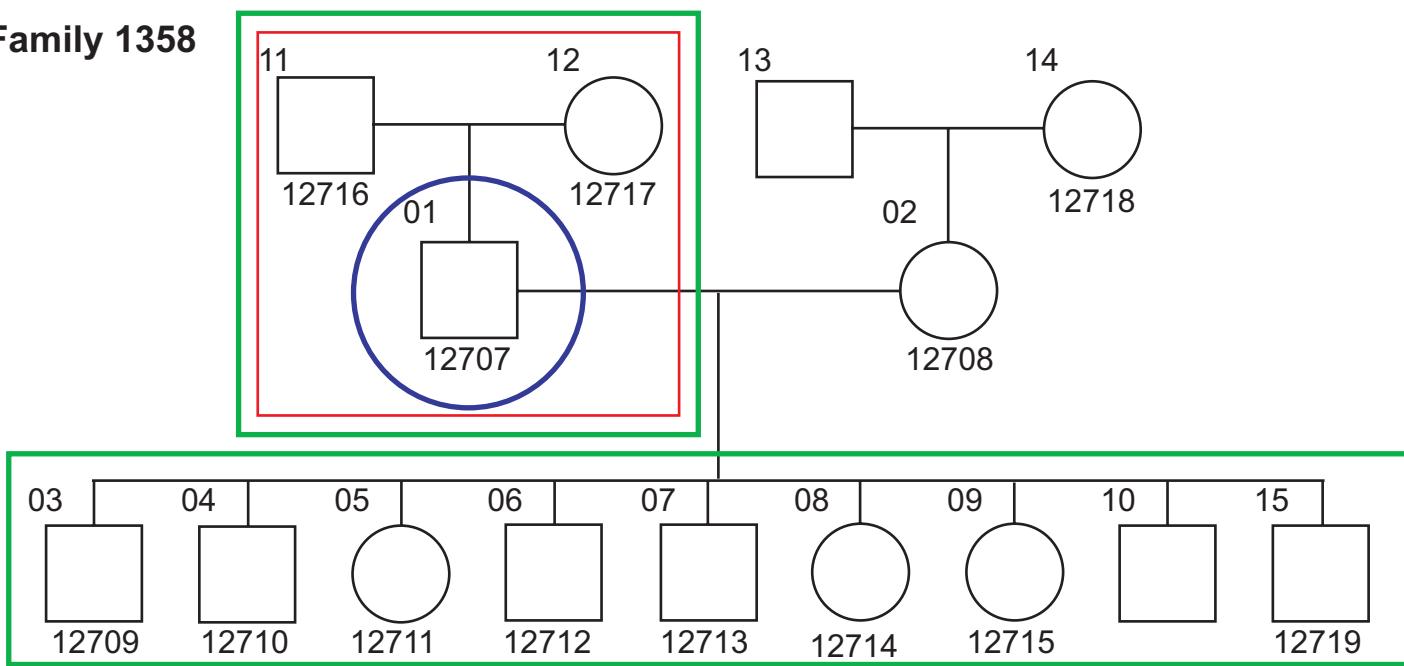

Family 1408

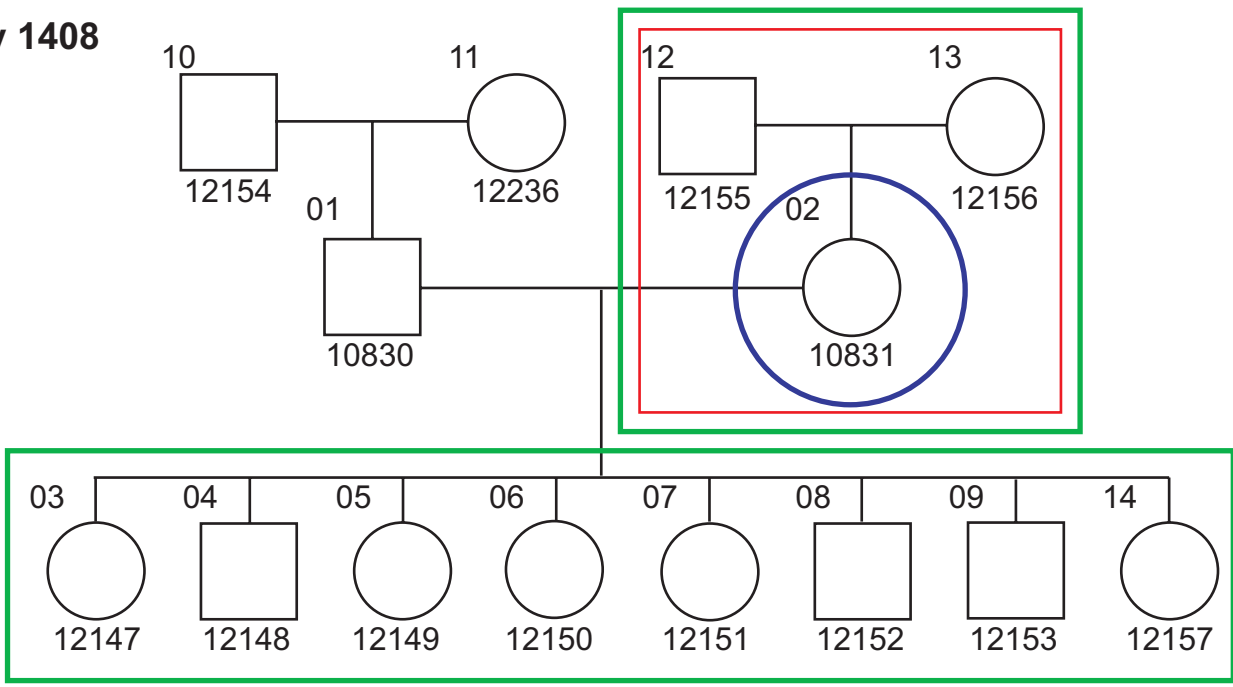

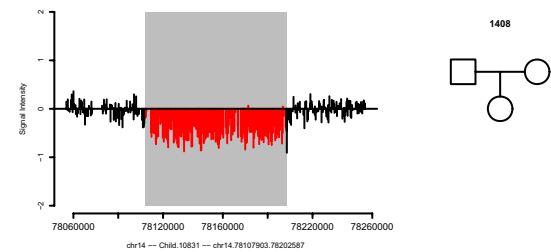
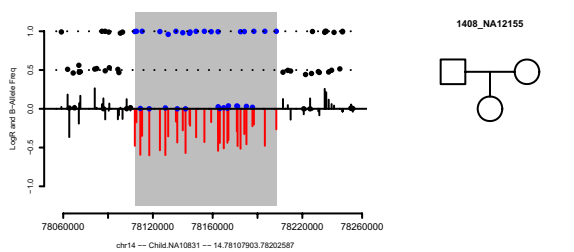
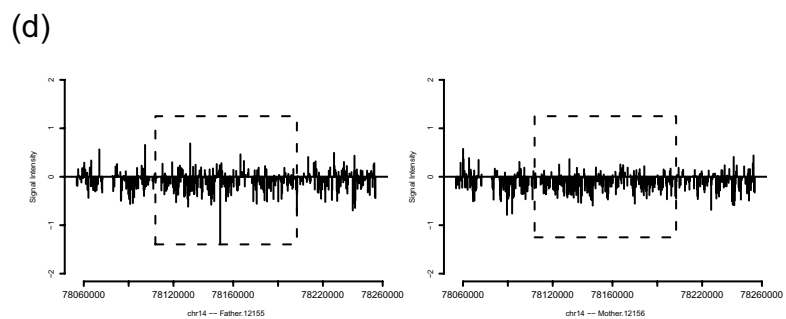
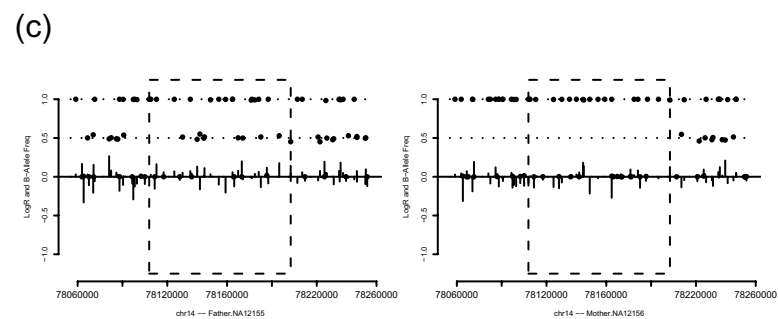
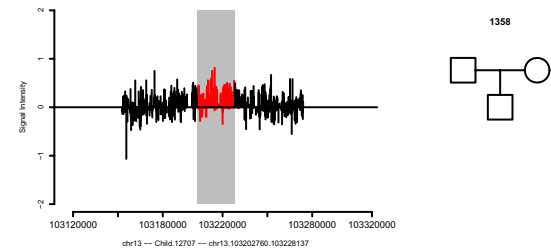
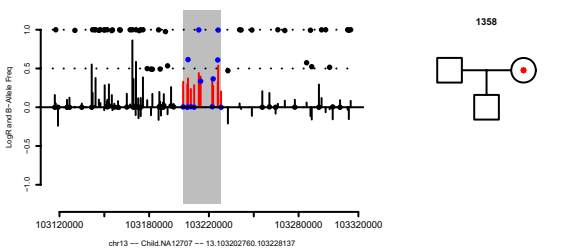
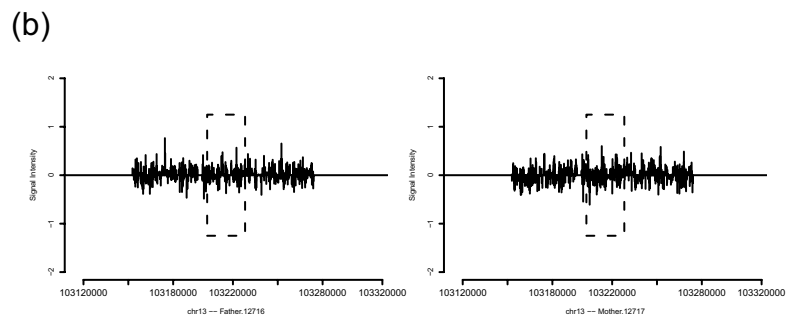
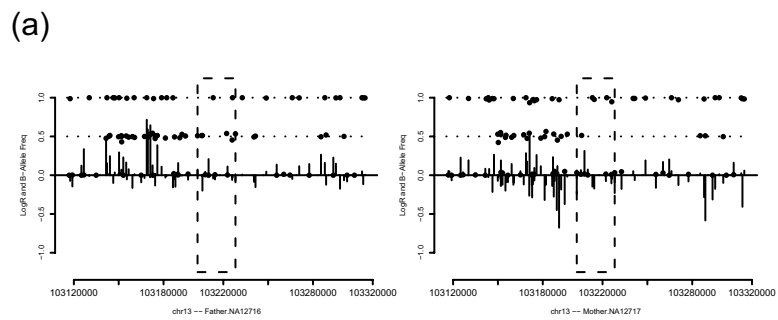

Itsara et al. Supplemental Figure 3.

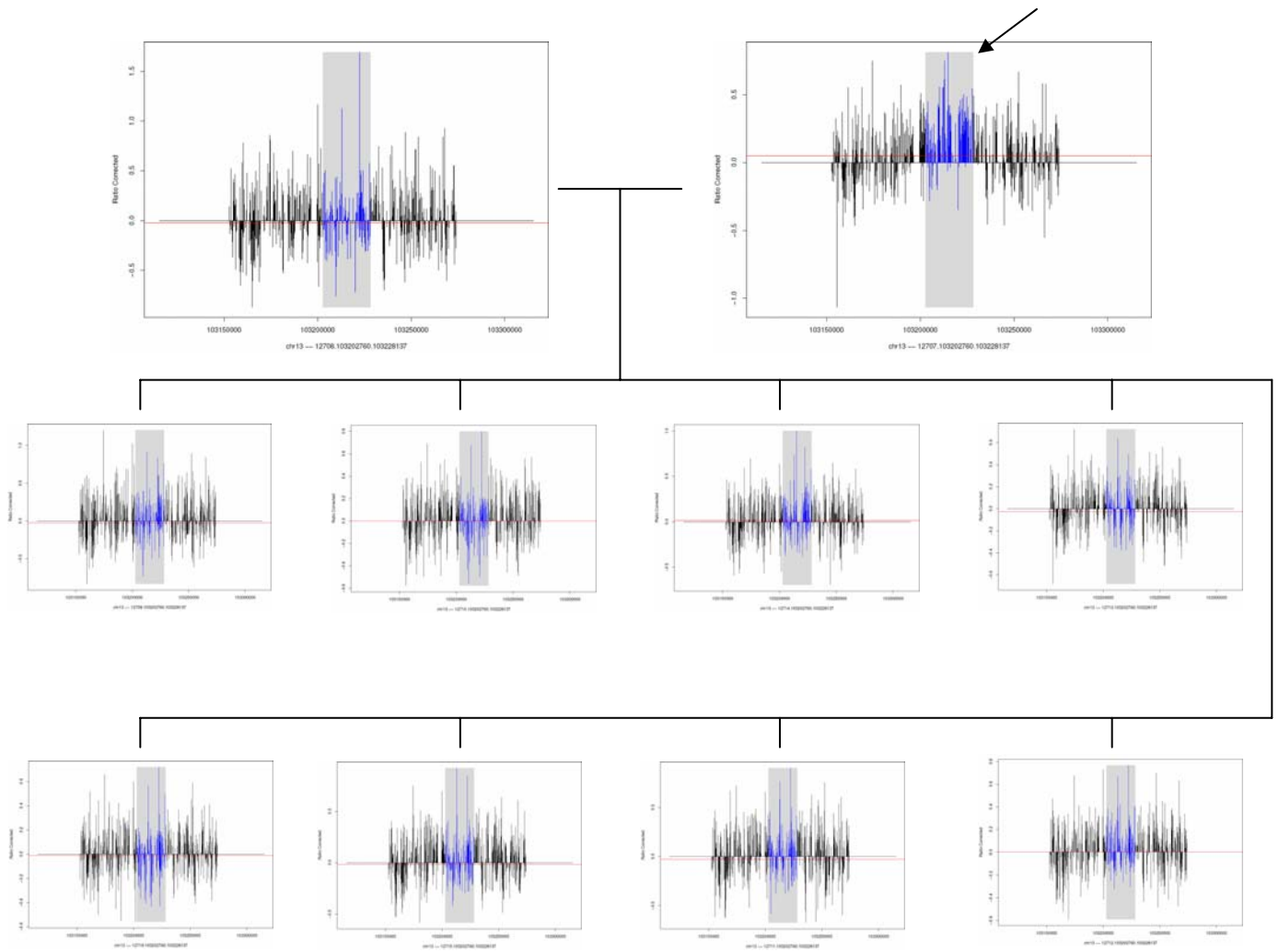

Itsara et al. Supplemental Figure 4.

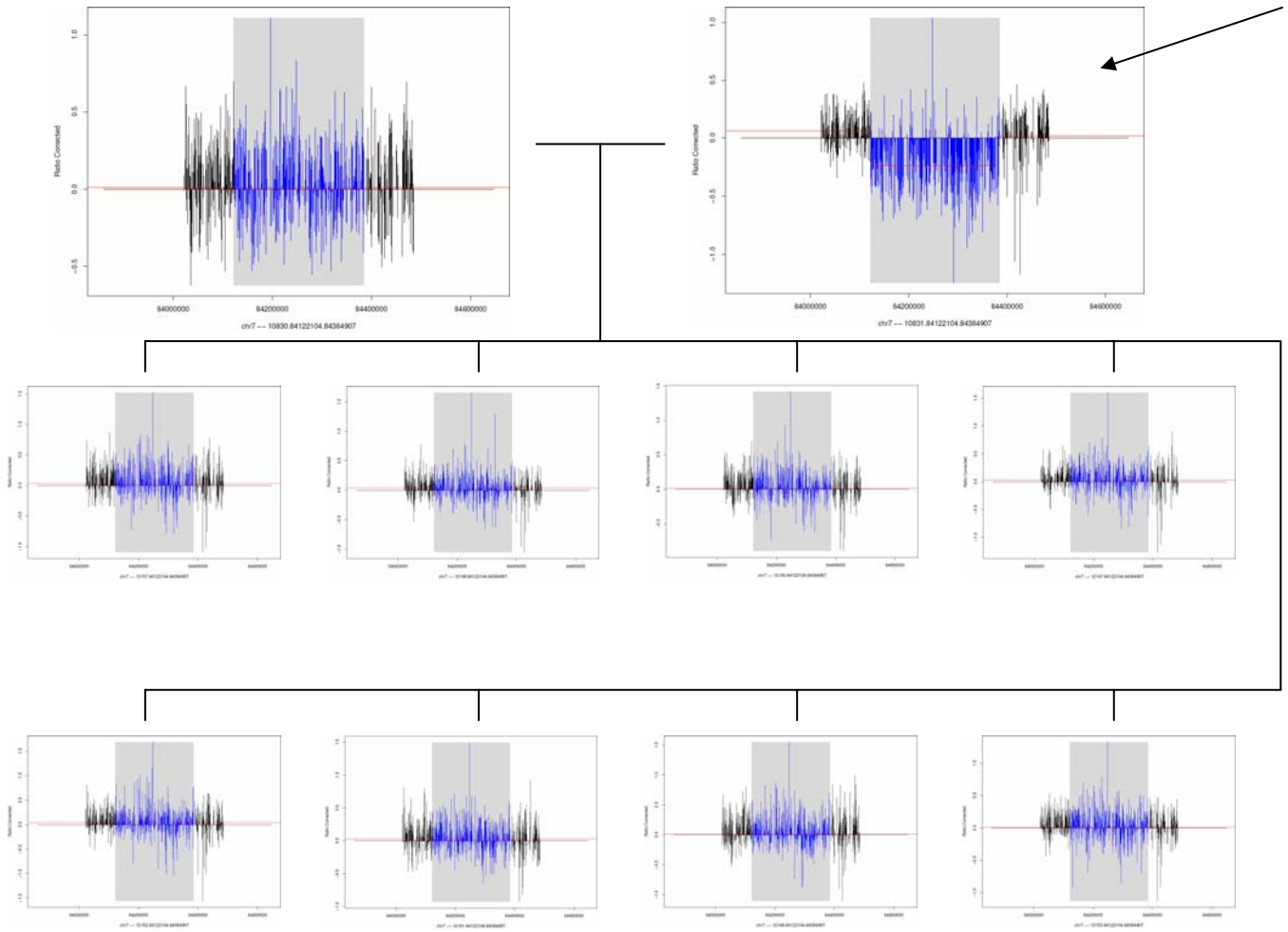

Family 1358

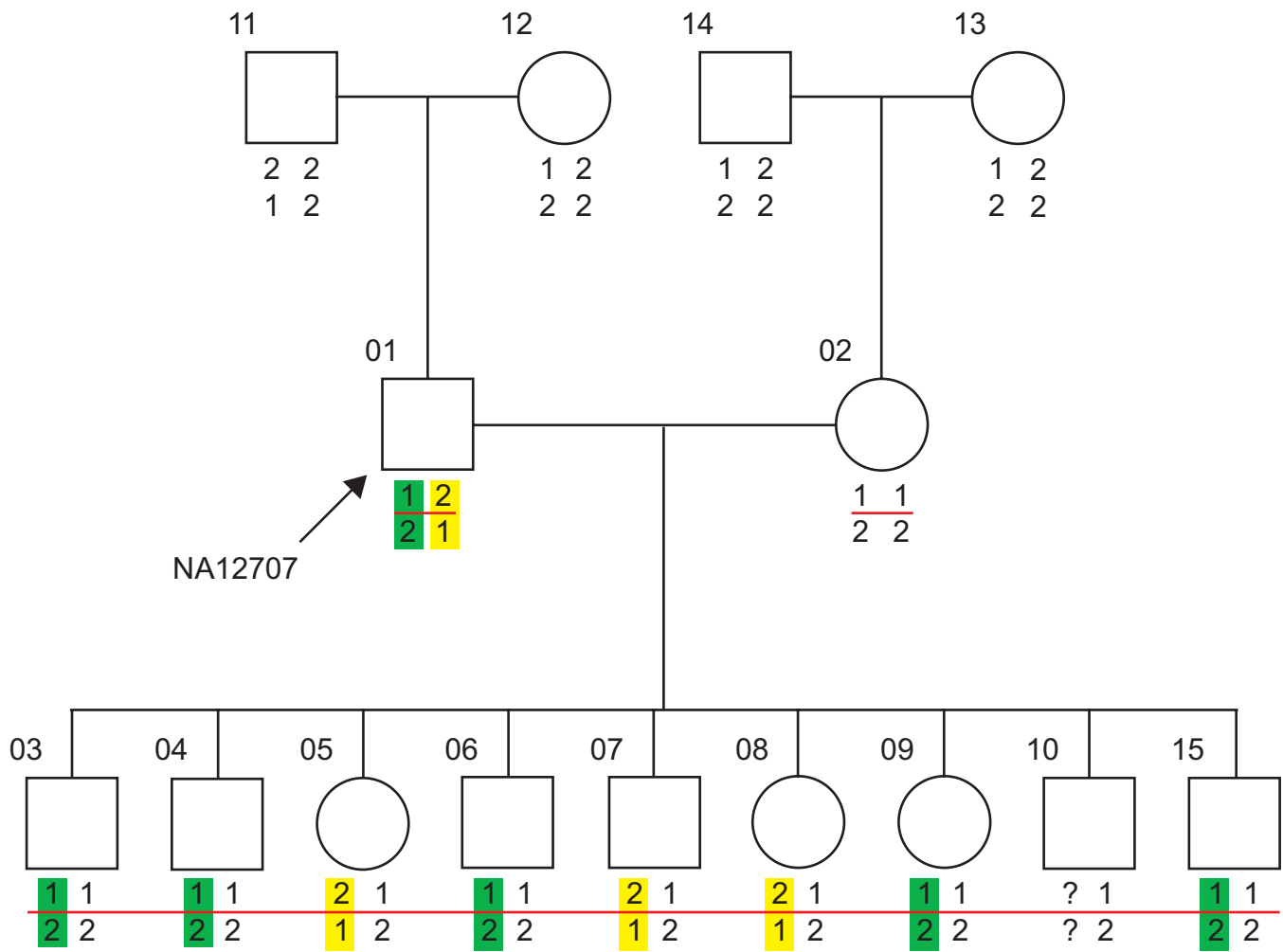

NA12707

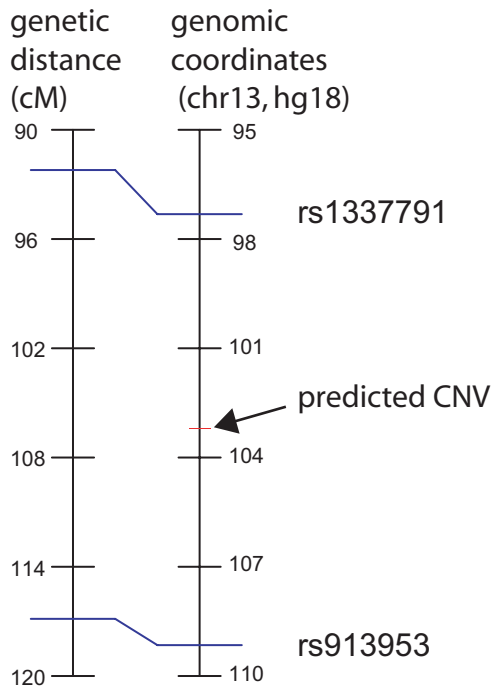

Family 1408

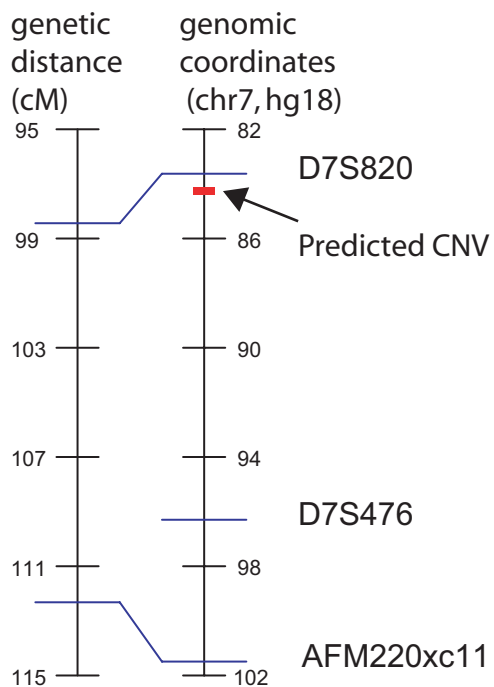
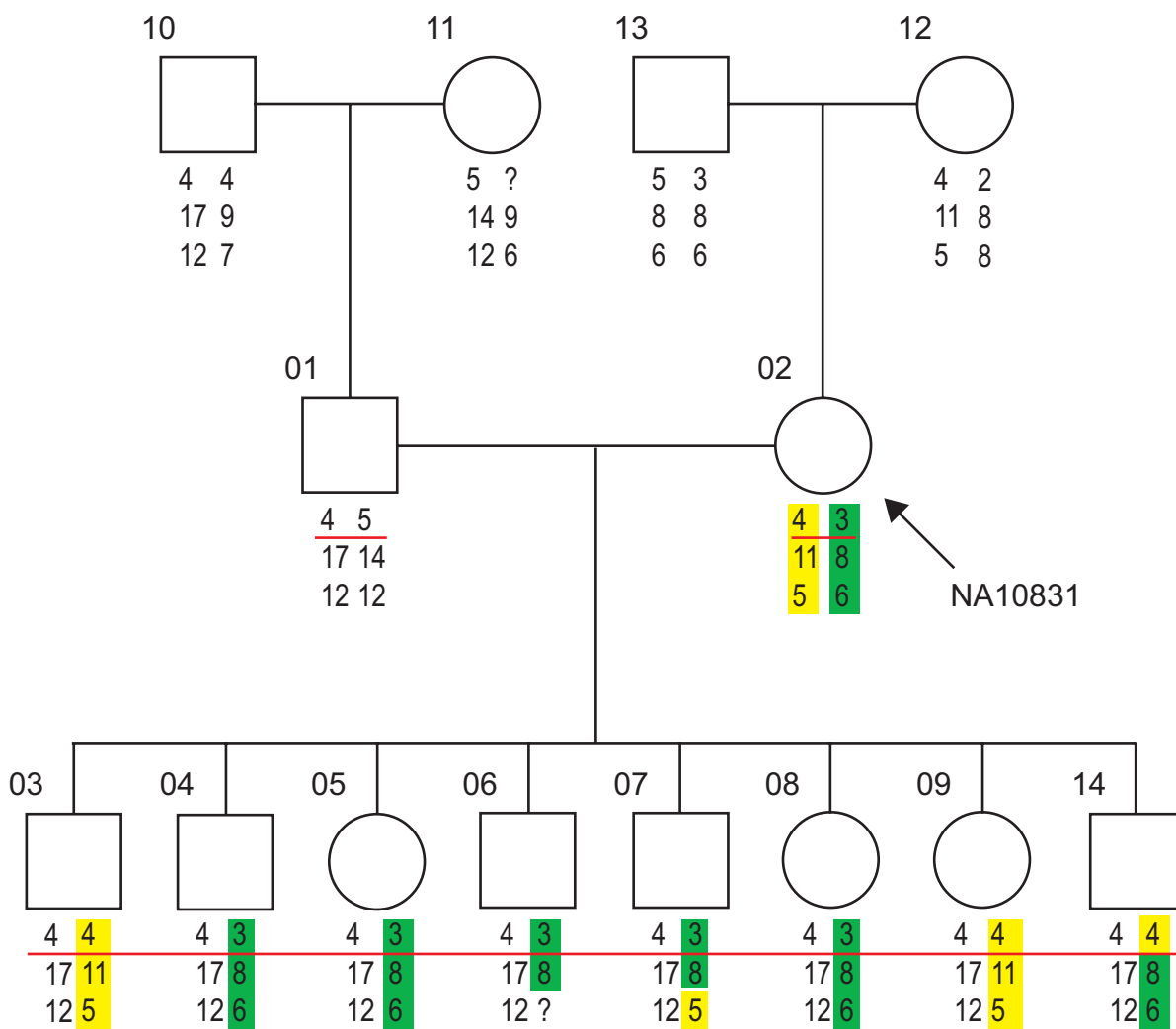

Sample 10871, chr1:106371568-1163271950

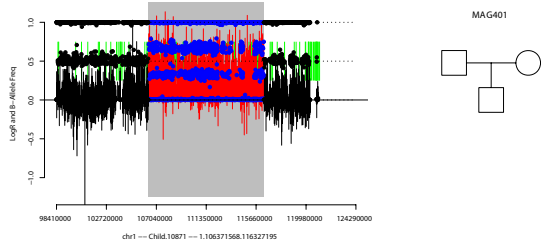
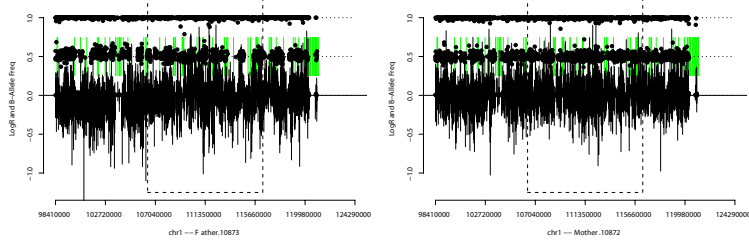

Sample 10942, chr12:98433426-98580660

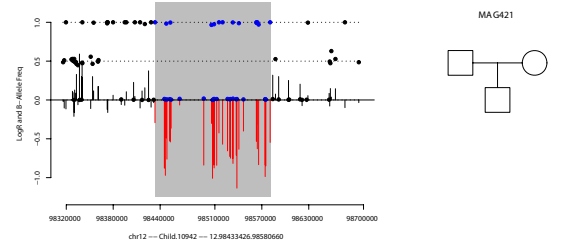
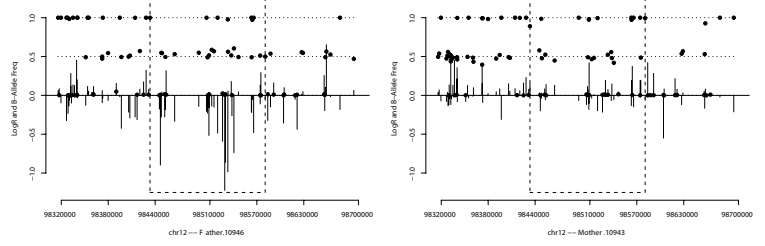

Sample 11020, chr16:15387380-16197033

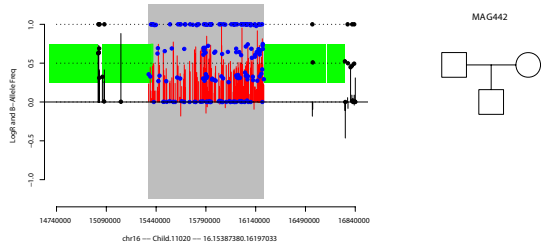
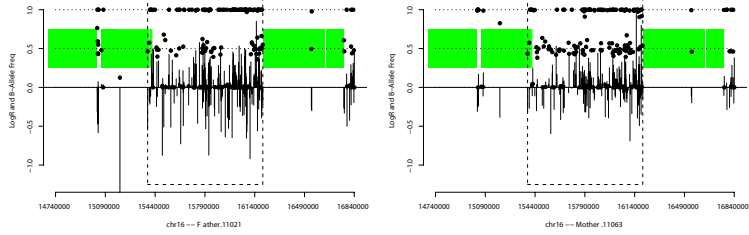

Sample 10653, chr16:54000488-54351802

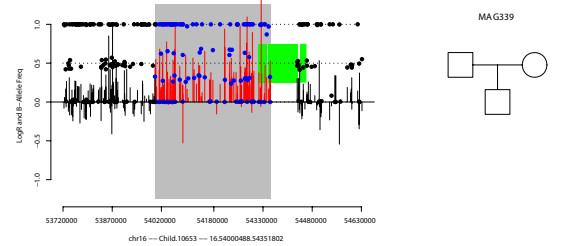
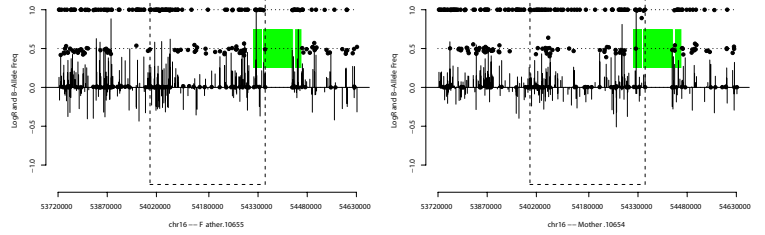

Sample 10054, chr18:45282024-47194369

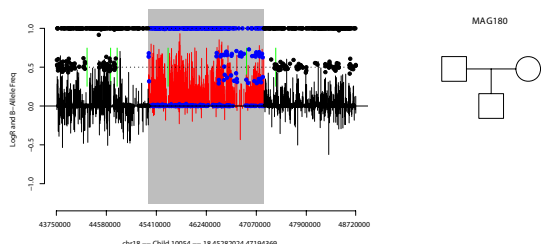
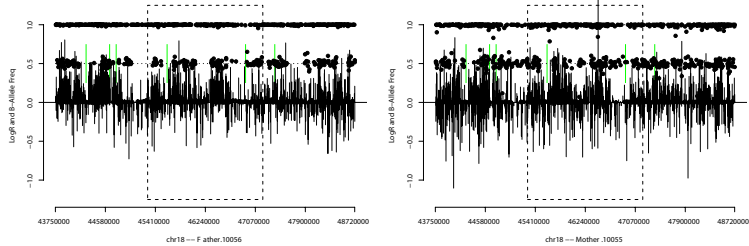

Sample 10186, chr2:60591731-60750244

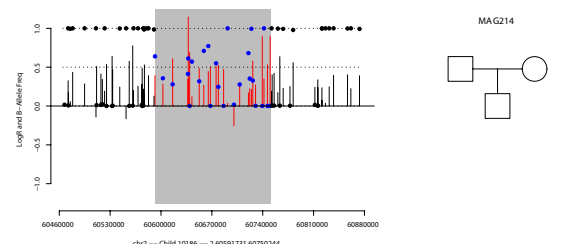
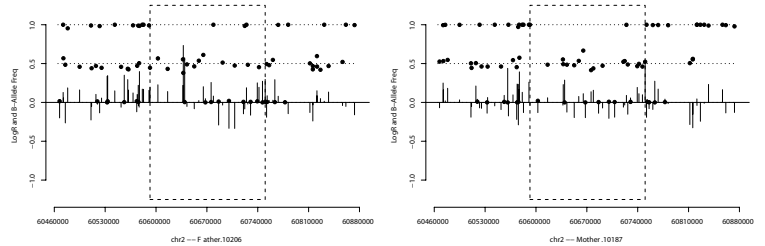

Sample 10421, chr22:17295347-19792353

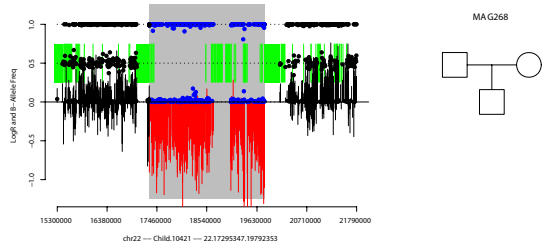
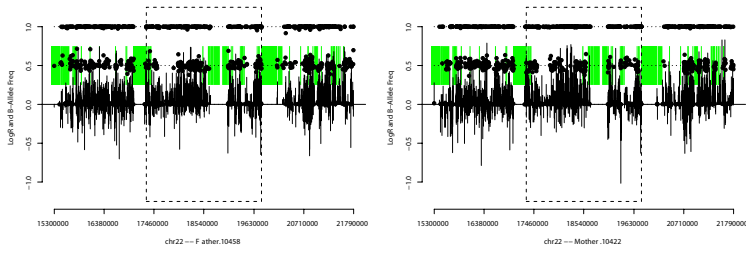

Sample 2648, chr22:17295963-19782237

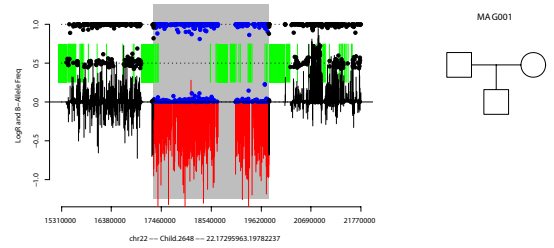
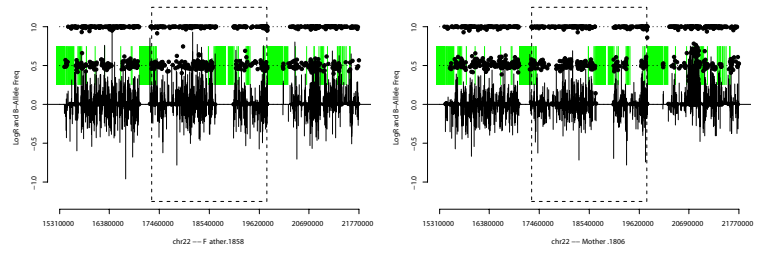

Sample 10846, chr4:179040624-179102293

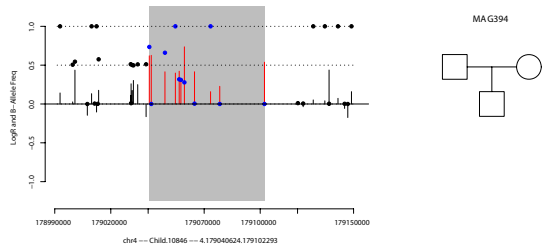
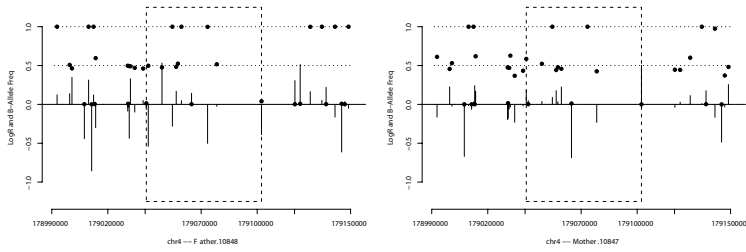

Sample 723, chr11:38249818-38282959

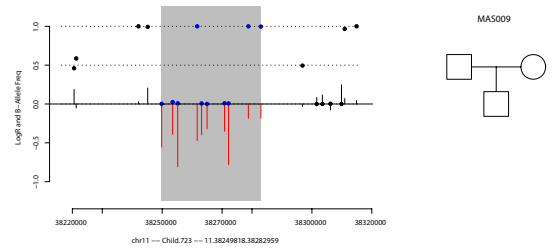
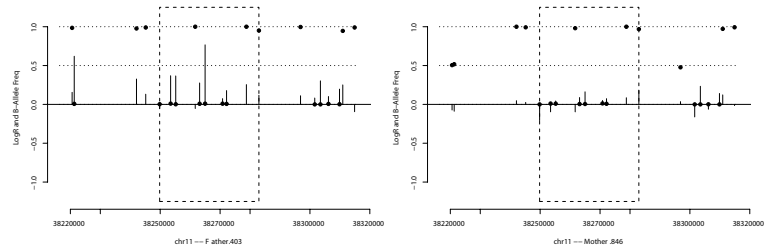

Sample 593, chr1:195089653-195163711

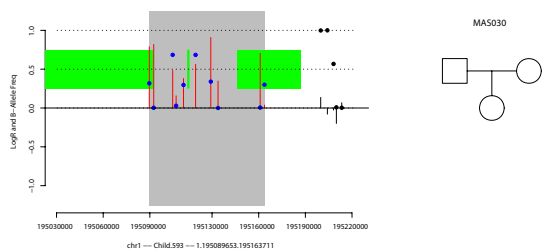
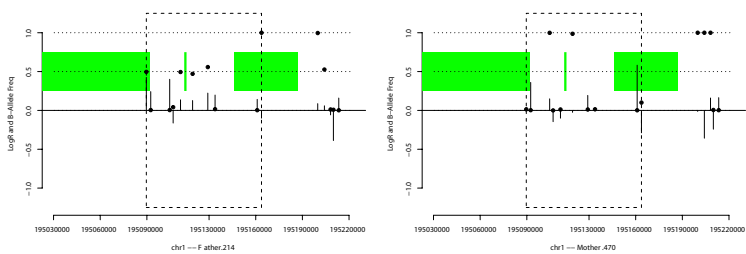

Itsara et al. Supplemental Figure 8

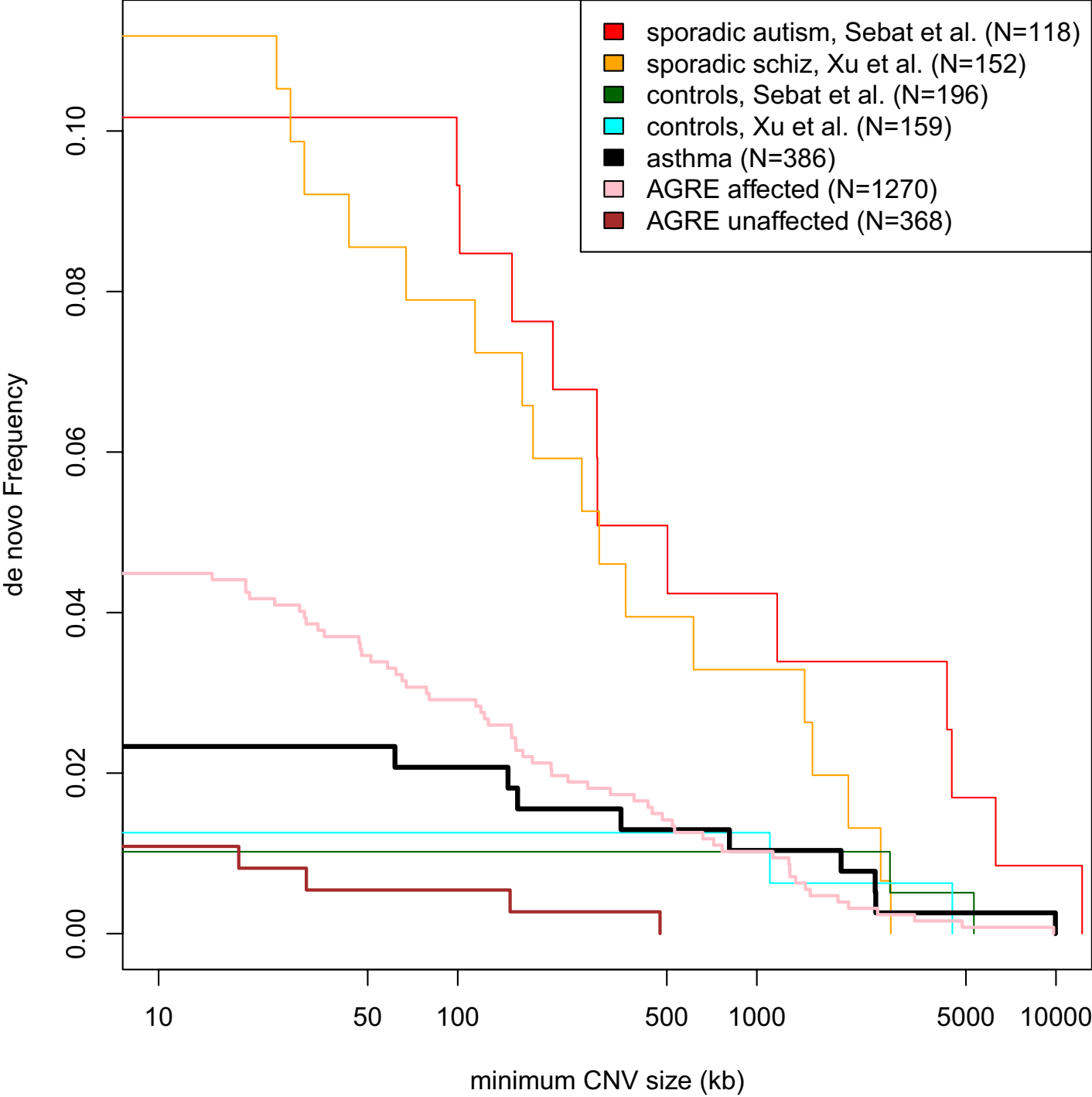

A

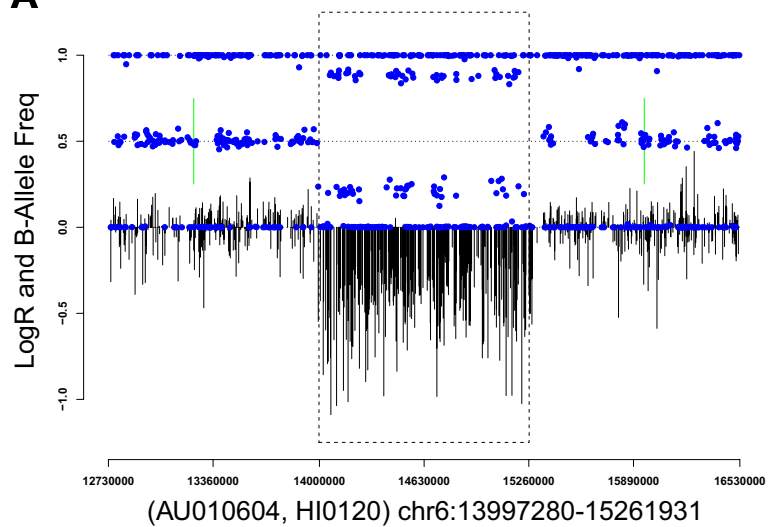

B

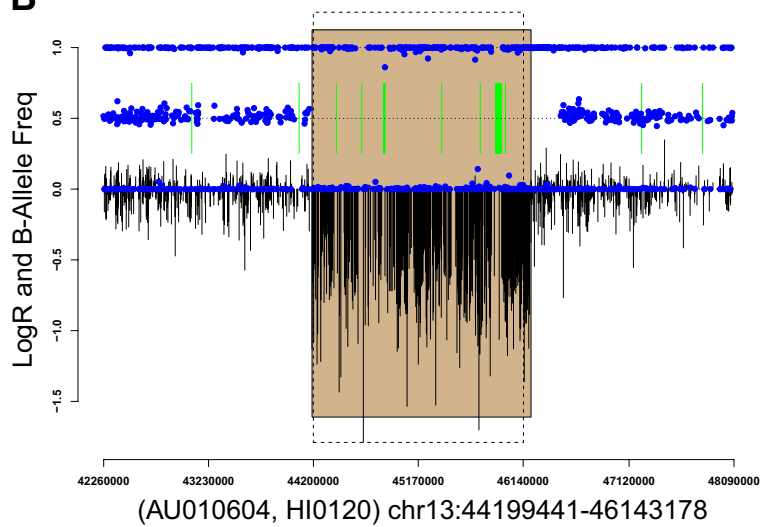

C

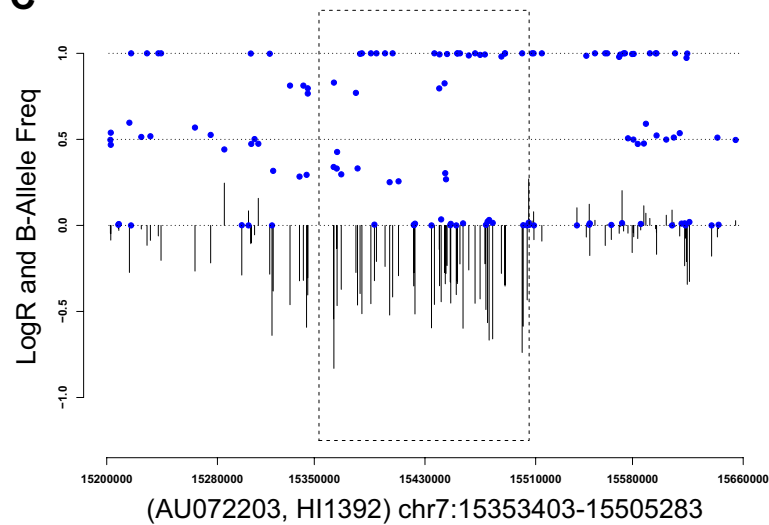

D

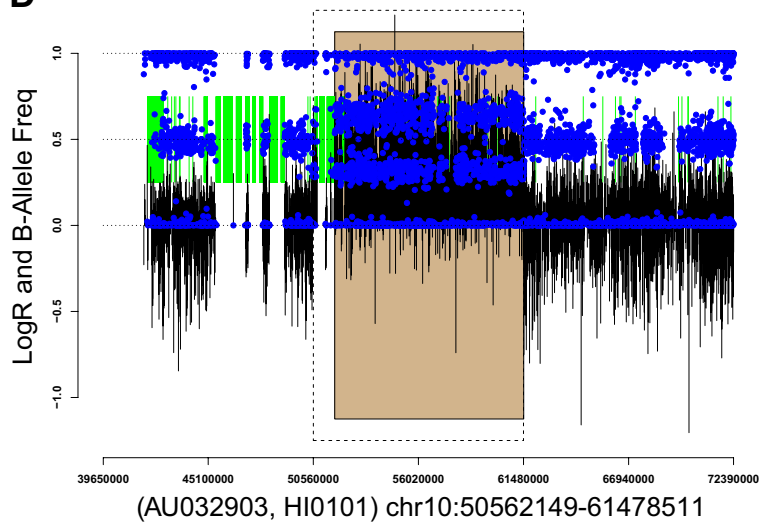

E

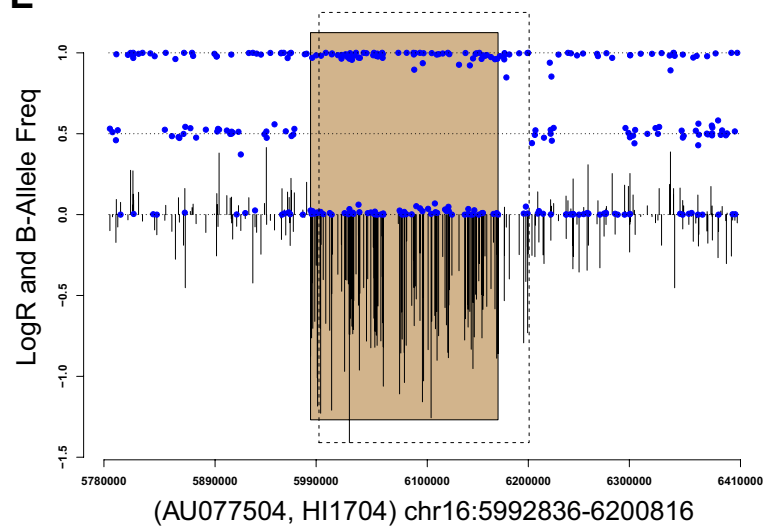

F

